

# Electric Indoor Grills

Use and Care Instructions  
plus recipes and tips for indoor  
grilling with great outdoor flavor.

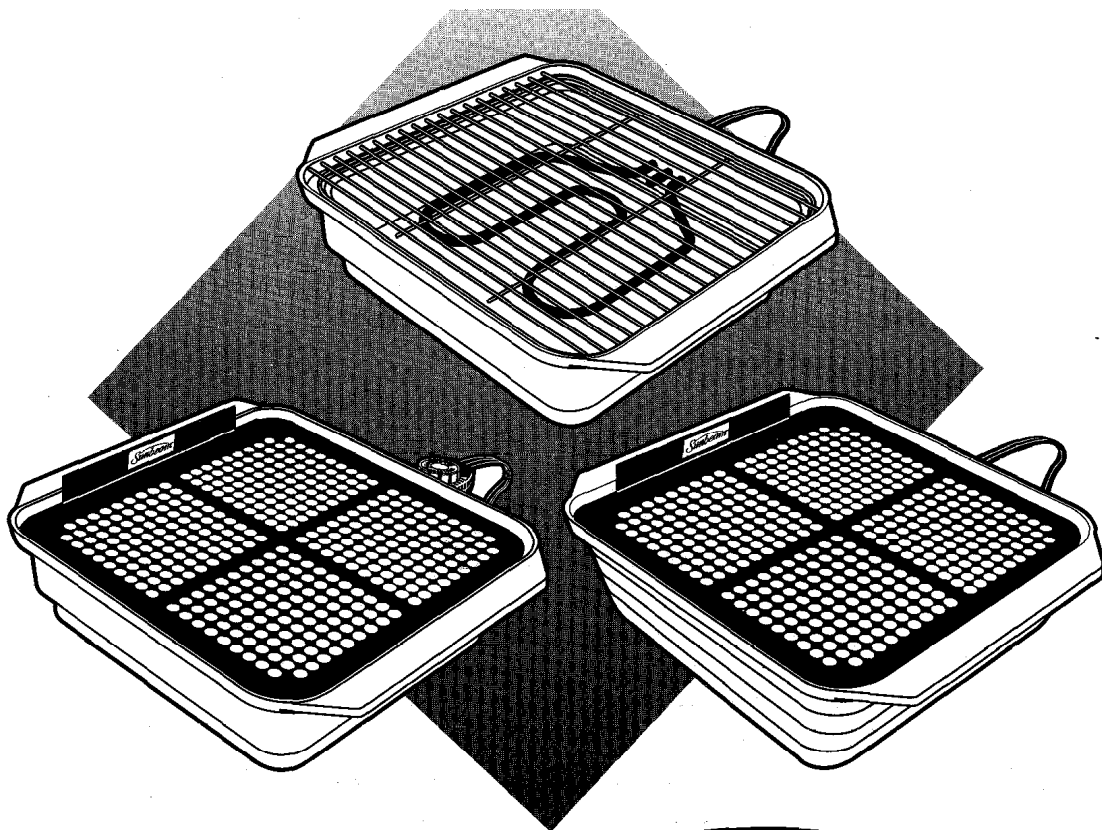

*Sunbeam*<sup>®</sup>

# IMPORTANT SAFEGUARDS

When using electrical appliances; basic safety precautions should always be followed, including the following:

1. **READ ALL INSTRUCTIONS.**
2. Do not touch hot surfaces. Use handles.
3. To protect against electrical shock, do not immerse cord, plugs, power controller, or heat element in water or other liquid.
4. Close supervision is necessary when any appliance is used by or near children.
5. Unplug from outlet when not in use and before cleaning. Allow to cool before putting on or taking off parts.
6. Do not operate any appliance with a damaged cord or plug or after the appliance malfunctions, or has been damaged in any manner. Return appliance to the nearest authorized service facility for examination, repair or adjustment.
7. The use of accessory attachments not recommended by the appliance manufacturer may cause injuries.
8. Do not use outdoors.
9. Do not let cord hang over edge of table or counter, or touch hot surfaces  
10. Do not place on or near a hot gas or electric burner, or in a heated oven.
11. Extreme caution must be used when moving an appliance containing hot-oil or other-hot liquids.
12. Always attach plug to appliance first then plug cord into wall outlet. To disconnect, first remove plug from wall outlet, or, if using a Variable temperature control, turn control to "off", then remove plug from wall outlet.
13. Do not use appliance for other than its intended use. Household use only.
14. A grill that is plugged into an outlet should not be left unattended.
15. Fuels such as charcoal briquettes are not to be used with this appliance.
16. Do not cover grill with any metal, such as aluminium foil or pot cover, as this will cause excessive heat build-up.

## SAVE THESE INSTRUCTIONS

**PLEASE NOTE:** A short detachable power supply cord is provided to reduce the risk resulting from becoming entangled in or tripping over a longer cord. Longer detachable power cords or extension cords are available and may be used if care is exercised in their use. If a longer detachable power supply cord is used: (1) the marked electrical rating of the cord set or extension cord should be at least as great as the electrical rating of the appliance; (2) if the appliance is of the grounding type, the extension cord should be a grounding type 3-wire cord; and (3) the longer cord should be arranged so that it will not drape over the counter top or tabletop where it can be pulled on by children or tripped over unintentionally.

## COOKING WITH YOUR ELECTRIC INDOOR GRILL

**GENERAL OPERATING INSTRUCTIONS:** Your new Electric Indoor Grill is an indoor open air broiler that, coupled with creative marinading and basting, brings great outdoor barbecue flavor indoors. With its specially designed reflective drip pan and bowl, **you** get **fat-free** cooking, no mess, virtually no smoke, easy clean-up and great taste in one great product. This grill is simple to use. In less than five minutes it can be set up and ready to cook.

**HOW TO ASSEMBLE YOUR NEW GRILL:** Unpack the grill. Wash the GRIFFO™ porcelain coated grid (or wire grate) before using for the first time to remove any factory oil. Set base on a counter near an outlet. Set the aluminum drip pan next to the base. Inset the support rod into holes on the sides of the drip pan. ① Place heating element in the drip pan, resting the extended portion on the support bar and slipping the element bracket into the notch cut in one side of the drip pan as shown. ② Tilting the opposite end of the drip pan, insert the bracket end into the window on the side of the base and position drip pan in base. The drip pan and element will lock into place. ③ Plug the electric cord (or the variable temperature control) into the cooking element. ④ Place the GRIFFO™ porcelain coated grid (or wire grate) on top of the base and you're ready to grill.

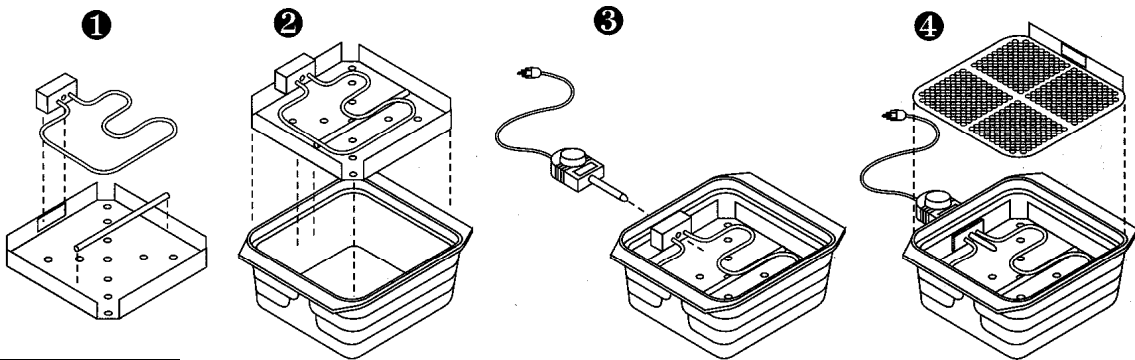

**COOKING ON YOUR ELECTRIC INDOOR GRILL:** Plug the cord into a 115-volt wall outlet (no other heating appliances should be plugged into the same circuit while cooking with the grill). The grill will start heating immediately and be hot enough for broiling in 2-3 minutes. In general, turn foods only once. If cooking only one or two items, place them squarely over the element towards the center of the grill. Cooking times are approximately the same as an indoor electric oven broiler (but the electric use is only 50% as much). When juices start to rise and appear on the surface of the meat or seafood being cooked, it is time to turn the food. During broiling, the hot cooking element may give off an occasional puff of smoke if drops of fat or sauce hit it directly. However, the grill will cook all but the fattiest foods with no smoke. The base stays relatively cool. The drip pan shields the drippings from the heat. The drippings rest in the bottom of the base. After each use, or when grilling more than one batch of food, disconnect the power and empty the grease from the base and pan when cool enough to handle.

For easier cleaning of the parts later, lightly spray the grid, and drip pan with Pam® or other vegetable oil spray before grilling.

If it should be necessary to move the grill, grasp the handles and gently lift the grill. Do not slide the base across the counter as it may scratch the surface.

**CLEANING UP:** Remove the plug from the outlet. **When grill is cool,** unplug the element and wipe any grease from it with a damp cloth or sponge. **DO NOT IMMERGE COOKING ELEMENT OR CORDSET IN WATER OR ANY OTHER LIQUID.** Empty the grease which has collected in the grill base or in the drip pan. The base, grid, drip pan, and support bar can be washed in the sink or dishwasher. Clean after each use.

## FEATURES ON YOUR NEW ELECTRIC INDOOR GRILL

### **Ceramic base (some models only)**

The ceramic base of your indoor grill was baked naturally in a kiln. Each ceramic base is different from the next in its glaze color and surface texture. The hand-crafted nature of the clay shaping procedure can result in slight imperfections and narrow openings (fissures) on the inside of the base. These distinguishing characteristics are typical and do not affect the structure or operation of the product. The ceramic base is dishwasher safe.

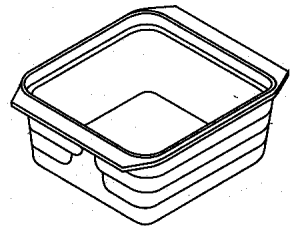

**Nu-Stone base (some models only)** Nu-Stone is a new high heat-resistant thermal polyester. It is half the weight of its ceramic counterpart, and is also more durable. Nu-Stone withstands temperatures over **400° F** and still stays cool to the touch. The Nu-Stone base is dishwasher safe.

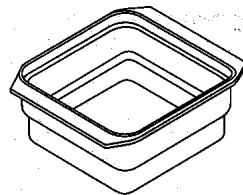

**Heating element** The Heating element's unique shape provides better heat distribution over the entire grid. This prevents cold spots in the corners so you can grill more food at one time, and at a faster, more efficient rate. After grilling, just wipe the element clean with a damp cloth or sponge.

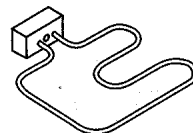

**One piece drip pan** The one piece drip pan quickly moves grease away from the heating element for virtually smokeless grilling. The drip pan and the stabilizer bar are dishwasher safe.

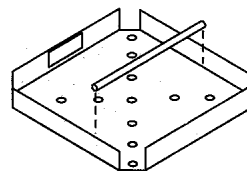

### **Adjustable temperature control (some models only)**

Your new Electric Indoor Grill is equipped with the finest infinitely adjustable thermostat control available for an indoor grill. The marked heat settings range from "LOW" (approximately **175° F**) to "MED" (approximately **300° F**) to "HIGH" (approximately **400° F**). At all settings other than "HIGH" the heat control will cause the power to cycle on and off at varying rates. The lower the setting, the longer the "OFF" phase of the cycle. The "ON" indicator light tells you the grill is functioning. It goes out during the "OFF" phase of the cycle or when turned to "OFF".

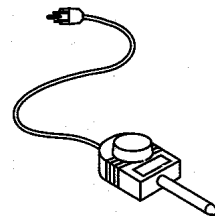

**GRIFFO™ Porcelain Coated Grid (some Models only)** The GRIFFO™ porcelain coated grid is specially designed to grill delicate food like fish and vegetables, preventing them from falling apart. It grills food faster and sears in the juices. The grid is dishwasher safe.

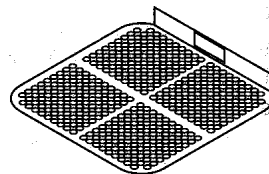

## GRILLING TIPS

Now you can enjoy great barbecued food all year around. *Here are some tips for healthier, safe cooking and perfect results every time:* ♥ Use lean cuts of meat, trim off fat. ▼ Avoid using fatty foods. ▼ Cut meat, poultry, and fish into smaller portions for quick and easy grilling. ▼ Use fish and shellfish or chicken lightly brushed with oil or seasonings. ▼ To add a hickory or outdoor grilled flavor to your food, simply brush liquid smoke over your food just before serving. You can find liquid smoke next to the barbecue sauce in your local grocery store.

Any of the foods you would normally broil on an outdoor grill or in a range broiler can be done on your new Electric Indoor Grill. Here are some suggested foods and cooking times, based on the food being at refrigerated temperatures. Remember to preheat your grill for 2-3 minutes.

| FOOD   | COOKING TIME  |
|--|---|
| <b>Hamburger,</b><br>3/4-inch thick                                    | <b>rare</b> – 7 min. per side<br><b>medium</b> – 10 min. per side<br><b>well-done</b> – 12 min. per side  |
| <b>Steak (Sirloin, T-Bone, Porterhouse, Strip)</b><br>3/4-inch thick   | <b>rare</b> – 6 min. per side<br><b>medium</b> – 8 min. per side<br><b>well-done</b> – 10 min. per side   |
| 1 1/2-inch thick   | <b>rare</b> – 15 min. per side<br><b>medium</b> – 20 min. per side<br><b>well-done</b> – 25 min. per side |
| <b>Chicken (Broiler, fryer)</b><br>3 legs, 3 thighs<br>4 breast halves | 25 min. per side until tender<br>20 min. per side until tender  |
| <b>Country-style spareribs</b><br>(thick-cut ribs)                     | 25 min. per side plus final<br>10 min. of basting with sauce  |
| <b>Fish Steaks (Halibut, Swordfish, Salmon)</b>                        | Brush with mixture of oil and<br>lemon juice, broil 3 min. per side<br>or until it flakes easily          |

# RECIPES

Here are some great recipes to get you started.  
ENJOY COOKING ON YOUR NEW ELECTRIC INDOOR GRILL!

## Quick Chick

- 1/2** cup extra-virgin olive oil
- 1** 0.06 ounce envelope Italian salad dressing mix
- 1/4** cup lemon juice
- 4** skinless, boneless chicken breast halves

Combine olive oil, Italian salad dressing mix, and lemon juice. Add chicken breasts, turn to coat well. Let stand for 5 minutes. Preheat Electric Indoor Grill for 2-3 minutes. If you have variable temperature control, turn it to the "HIGH" setting. Place chicken on lightly oiled grill grid or grate. Grill, turning occasionally, for about 10 to 12 minutes, until white throughout but still moist.

**Serves 4.**

## Seafood Kabobs Scampi

- Sea scallops, about 4 per person**
- Jumbo shrimp, shelled, raw, about 4 per person**
- Thick sliced bacon, 2 slices per person**

*Sauce for basting:*

- 2** cloves garlic, minced
- 1 1/2** teaspoon salt
- 1/4** cup salad oil
- 1/2** cup lemon juice
- 1** tablespoon grated onion
- pepper and paprika to taste**

On an 8-inch (approx.) metal or bamboo skewer, "weave" a slice of bacon over and then under alternating scallops and shrimp, using 2 of each and 1 bacon strip per skewer. Allow 2 skewers per person. Combine remaining ingredients and brush on kabobs. Preheat Electric Indoor Grill for 2-3 minutes. If you have variable temperature control, turn it to the "HIGH" setting. Broil **15-20** minutes, turning and brushing until bacon is done and seafood is slightly brown.

Serve with rice.

## Veal Chops with Sage

- 6 veal loin chops, cut 3/4" thick
- 2 tablespoons chopped fresh sage, or
- 1 -1/2 teaspoons ground dried sage
- 3 garlic cloves, crushed
- 1-1/2 teaspoons salt
- 1/4 teaspoon freshly ground pepper
- 3 tablespoons dry white wine or fresh lemon juice
- 3 tablespoons olive oil

Rub veal chops with sage, garlic salt and pepper. Drizzle wine and olive oil over meat. Cover with plastic wrap and marinate, 1 to 2 hours at room temperature, or overnight in refrigerator, turning occasionally. Preheat Electric Indoor Grill for 2-3 minutes. If you have variable temperature control, turn it to the "HIGH" setting. Grill veal chops, turning once or twice until browned outside and just barely pink at center, about 10 to 12 minutes total. Serves 6.

## 2 YEAR LIMITED WARRANTY

This product is warranted for two years from date of purchase to be free of mechanical and electrical defects in material and workmanship. The manufacturer's obligation hereunder is limited to repairing such products during the warranty period, provided the product is sent prepaid to a Sunbeam - Oster Household Products Authorized Independent Service Center. This warranty does not cover (a) normal wear of parts, (b) breakage, or (c) damage resulting from any of the following: negligent use or misuse of the product, use on improper voltage or current, use contrary to operating instructions, or disassembly, repair or alteration by any person other than an Authorized Service Center.

This warranty gives you specific legal rights, and you may also have other rights which vary from state to state.

Sunbeam - Oster Household Products  
117 Central Industrial Row  
Purvis, MS 39475

*Sunbeam® - Oster*

Household Products